

**clarion**

**APA4203**

**APA4162**

**4-CHANNEL**



**CAR AUDIO  
AMPLIFIER**

**OPERATION  
INSTALLATION  
MANUAL**

# TABLE OF CONTENTS

<b>Introduction</b> .....	<b>3</b>
<b>Description</b> .....	<b>4</b>
<b>Amplifier Inputs/Controls/Power Indicator</b> .....	<b>5</b>
<b>Connections for Speakers/Power</b> .....	<b>7</b>
<b>Applications</b> .....	<b>8</b>
<b>4-Channel Full-Range Stereo System</b> .....	<b>8</b>
<b>4-Channel Satellite/Subwoofer System</b> .....	<b>9</b>
<b>3-Channel Stereo/Mono System</b> .....	<b>10</b>
<b>2-Channel High Power System</b> .....	<b>11</b>
<b>Pre-Out Bi-Amped Stereo System</b> .....	<b>12</b>
<b>Mixed-Mode System</b> .....	<b>13</b>
<b>Installation</b> .....	<b>14</b>
<b>Mounting Precautions</b> .....	<b>14</b>
<b>Wiring Precautions</b> .....	<b>14</b>
<b>Setting Gain</b> .....	<b>17</b>
<b>Using The HP/LP Filter</b> .....	<b>18</b>
<b>Using The Bass Extender</b> .....	<b>18</b>
<b>Final System Checks</b> .....	<b>19</b>
<b>Troubleshooting</b> .....	<b>19</b>
<b>Everyone Wants "More Bass"</b> .....	<b>21</b>
<b>Specifications</b> .....	<b>22</b>

# INTRODUCTION

Whether you've purchased a Clarion APA4203 or APA4162 4-channel car audio amplifier, you've selected one of the finest mobile products on the market today. The APA4203 puts out 50 watts of continuous power into a 4-ohm load and delivers 75 watts (typical) into a 2-ohm load. The APA4162 is rated at 40 watts of continuous power or 65 watts (typical) for the same loads. Both models come with the following features:

- ◆ Full frequency response with low distortion and exceptional signal-to-noise performance
- ◆ Advanced circuit design features bridgeable and mixed-mode operation for use in a variety of 4-, 3-, or 2-channel systems
- ◆ Independent front/rear, LP (low-pass)/HP (high-pass) electronic crossovers each with a 12 dB per octave slope and full adjustment range (from 50 to 200 Hz) to aid in audio system design
- ◆ Variable bass extender circuit to reinforce low frequency signals that may be lost due to box design
- ◆ Non-fade summed-stereo outputs (on APA4203) for system expansion
- ◆ Ground loop isolation inputs with adjustable input level controls to accept a wide range of input signals (from 200 mV to 5 V)
- ◆ Remote turn-on with "soft-start" muting to prevent turn-on "thump"
- ◆ Regulated MOSFET power supply with low AM RFI and protection circuits for overheating and speaker shorts
- ◆ 2-ohm load capability to drive a variety of speaker systems
- ◆ Gold-plated input/output connectors and an external automotive-type fuse
- ◆ Aluminum heat sink for efficient dissipation of heat

In order to start enjoying your new Clarion 4-channel car audio amplifier as soon as possible, please read the remaining pages to plan your installation. When you're finished, fill out and send in the enclosed warranty card to protect your purchase and to aid us in any service-related questions. Also, **save your original bill of sale as a proof of purchase.**

## DESCRIPTION

The Clarion APA4203 (or APA4162) 4-channel car audio amplifier is an ideal choice for creating a variety of multi-channel sound systems. Both models features built-in system design flexibility that allows you to create a 2-, 3-, or 4-channel amplifier with a flip of a switch. Or you can configure the front (CH1/2) or rear (CH3/4) amplifier sections for mixed-mode operation to drive a set of satellite speakers and a subwoofer.

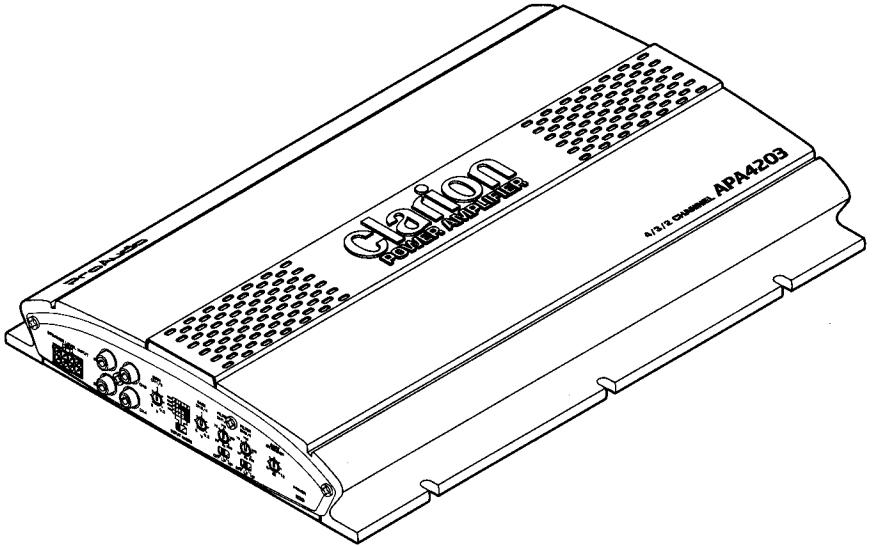

Figure 1. Clarion APA4203 4-channel car audio amplifier.

The built-in 12 dB-per-octave electronic crossovers let you tailor the sound of front and rear channels. Other amplifiers may offer a single filter, but this unit comes with two independent filters with adjustable crossover frequencies for high-pass or low-pass filtering. And you don't need to add external crossovers and cables, resulting in a cost-effective, efficient way to implement your design ideas.

Either amplifier uses a regulated MOSFET power supply for superior control of output wattage, regardless of input voltage or musical energy content. MOSFETs are chosen for their inherent characteristics to provide superior accuracy, stability, and control. A toroid-coil transformer yields maximum power transfer with minimum heat loss. Careful attention to circuit design keeps AM RFI at low levels, so you won't hear unwanted

noise when the level is cranked up. Protection circuits safeguard the amplifier when overheating and speaker shorts or improper load conditions occur. All connections and controls are on end panels and are straightforward and easy to understand. We use gold-plated RCA and barrier connectors to ensure the best electrical connection for your system. Included are external automotive-type fuses that are easy to replace.

## Amplifier Inputs/Controls/Power Indicator

The APA4203's (or APA4162's) front panel (see Figure 2) has SPEAKER LINE INPUT connections, (RCA) INPUT jacks, a GAIN CH1/2 control, an INPUT MODE switch, a GAIN CH3/4 control, FILTER CH1/2 and CH3/4 controls (for setting crossover frequencies for LP or HP filters), a BASS EXTENDER gain control, and a POWER indicator.

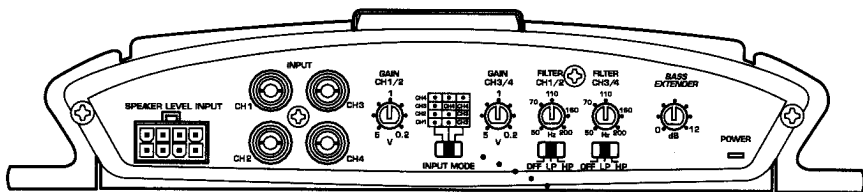
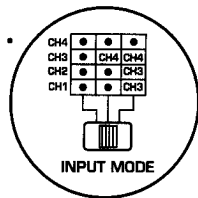

Figure 2. Front panel of a Clarion APA4203 or APA4162 amplifier. A reference chart (see detail) shows which inputs are active for a selected mode.



### Low-Level/Speaker-Level Inputs

The gold-plated RCA INPUT jacks, labeled CH 1 through CH 4, provide connections for a low-level front/rear stereo source. In addition, SPEAKER LEVEL INPUT connections are provided for installations where the source unit's RCA outputs are unavailable and direct connection to speaker outputs is the only choice (see *Specifications* on pages 22 and 23 for wire codes).

### Gain Controls

The CH1/2 GAIN and CH3/4 GAIN controls allows you to independently set the nominal operating levels of the amplifier's front and rear channels. The amplifier's wide range, 200 mV to 5 V for RCA inputs or 400 mV to 10 V for speaker-level inputs, can accommodate input levels from virtually any brand of source unit.

## DESCRIPTION

### **Amplifier Inputs/Controls/Power Indicator (Continued)**

#### **Channel Mode Switch**

The INPUT MODE switch allows you to select 4-, 3-, or 2-channel operation. A reference chart above the switch (see Figure 2 on the previous page) indicates which channel inputs, gain controls, and filters are active for your selection.

#### **High-Pass/Low-Pass Filter Controls**

The APA4203 (or APA4162) is equipped with 12 dB per octave electronic filters on front and rear channels for precise frequency attenuation with minimal phase distortion. The steep crossover slope keeps midrange tones out of the subwoofer and thereby eliminates an unnatural “nasal” tone quality in the audio system. A filter is activated by sliding the CH1/2 or CH3/4 FILTER switch to either HP or LP. Each one is fully adjustable between 50 and 200 Hz (via the CH1/2 FREQ or CH3/4 control) for a wide range of crossover points. Use this feature, along with your speaker manufacturer’s recommended crossover frequencies, to quickly design a more advanced system (see *Applications* starting on page 8).

*NOTE: If CH1/2 FILTER (or CH3/4 FILTER) is set to OFF, varying the CH1/2 FREQ (or CH3/4 FREQ) control will produce no effect.*

#### **Bass Extender Control**

The APA4203 (or APA4162) also features a “high-Q” (i.e., narrow frequency band) BASS EXTENDER circuit on channels 3 and 4 for 4- or 3-channel modes and is also active for mono connections. It acts much like an equalizer, with adjustable gain (from 0 to +12 dB) fixed at 40 Hz. Use this feature to tune low-frequency audio response to compensate for a less-than-ideal subwoofer enclosure design. The added boost produces rich, full bass tones that are normally difficult to reproduce in the car audio environment.

*NOTE: If bass extension is undesired, set BASS EXTENDER to 0 dB.*

## Connections for Speakers/Power

The APA4203's rear panel (see Figure 3) contains summed non-fade output jacks, speaker connections, external fuses, and power connections.

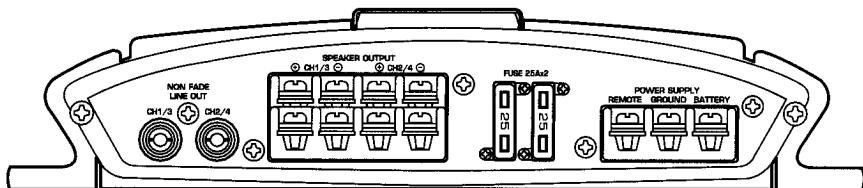

Figure 3. Rear panel layout of the Clarion APA4203 amplifier.

The APA4162's rear panel (see Figure 4) is similar, but without the summed non-fade output jacks.

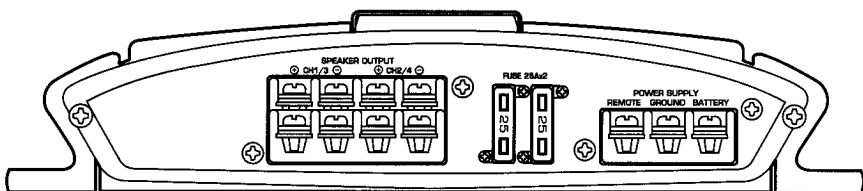

Figure 4. Rear panel layout of the Clarion APA4162 amplifier.

### Summed L/R Preamp Output (APA4203 Only)

The APA4203 includes stereo (gold-plated RCA) NON-FADE LINE OUT jacks, labeled CH1/3 and CH2/4, for sending summed L/R preamplified signals to additional amplifiers, as shown in Figure 9 (on page 12).

### Speaker Connections

The speaker terminals are gold-plated terminals and are labeled as FRONT CH1 (left) and CH2 (right) for front amplifiers and REAR CH3 (left) and CH4 (right) for rear amplifiers.

### Power Connections

The power connections are also gold-plated and are labeled REMOTE (for remote turn-on via source unit), GROUND, and BATTERY (+12 Vdc). Automotive-type 25 A fuses protect the front and rear amplifier circuits.

# APPLICATIONS

The Clarion APA4203 (or APA4162) 4-channel car audio amplifier can be used in a variety of system applications. We've enclosed six example systems to help plan your own installation (see Figures 5 through 10).

## 4-Channel Full-Range Stereo System

### FRONT PANEL SETTINGS

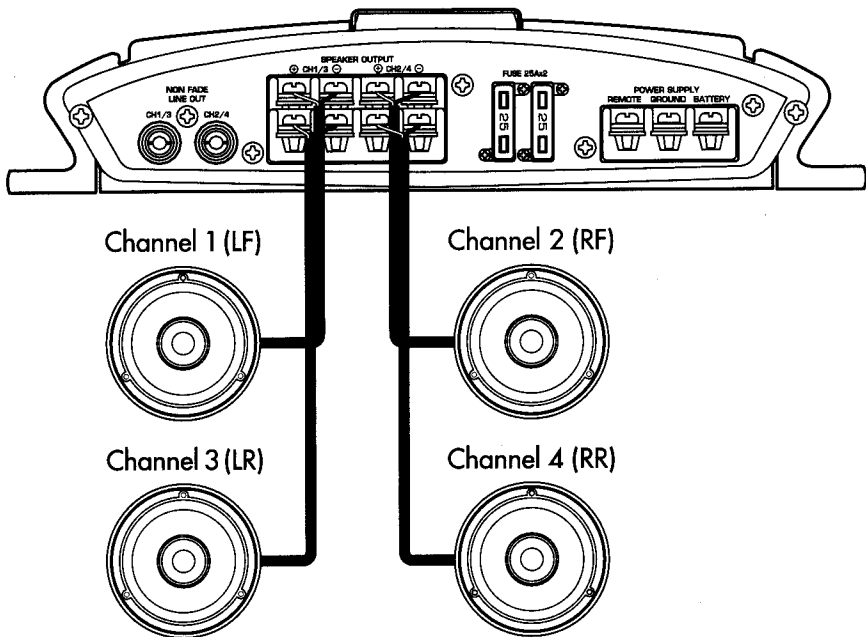
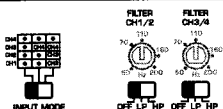
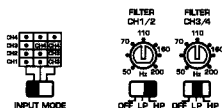

Figure 5. In this application, the APA4203 (or APA4162) is used as a 4-channel amplifier to drive four full-range speakers in stereo.



# 4-Channel Stereo System 2-Ch High Pass, 2-Ch Low Pass

## FRONT PANEL SETTINGS



Set Filter Frequencies to speaker manufacturer's specifications.

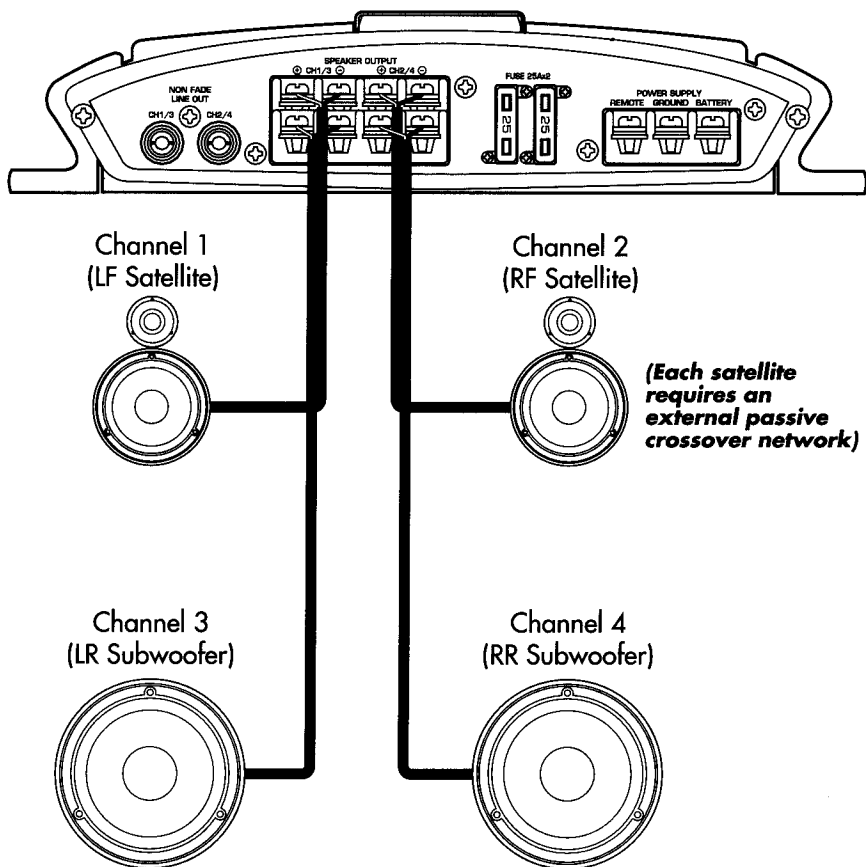
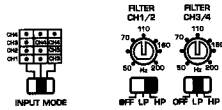

Figure 6. In this 4-channel system, an APA4203 (or APA4162) drives a pair of stereo satellites for the front and a pair of stereo subwoofers for the rear. Note the filter settings for this application.

# 2-Channel Stereo System With Low-Pass Bridged Mono Channel

## FRONT PANEL SETTINGS



Set Filter Frequencies to speaker manufacturer's specifications.

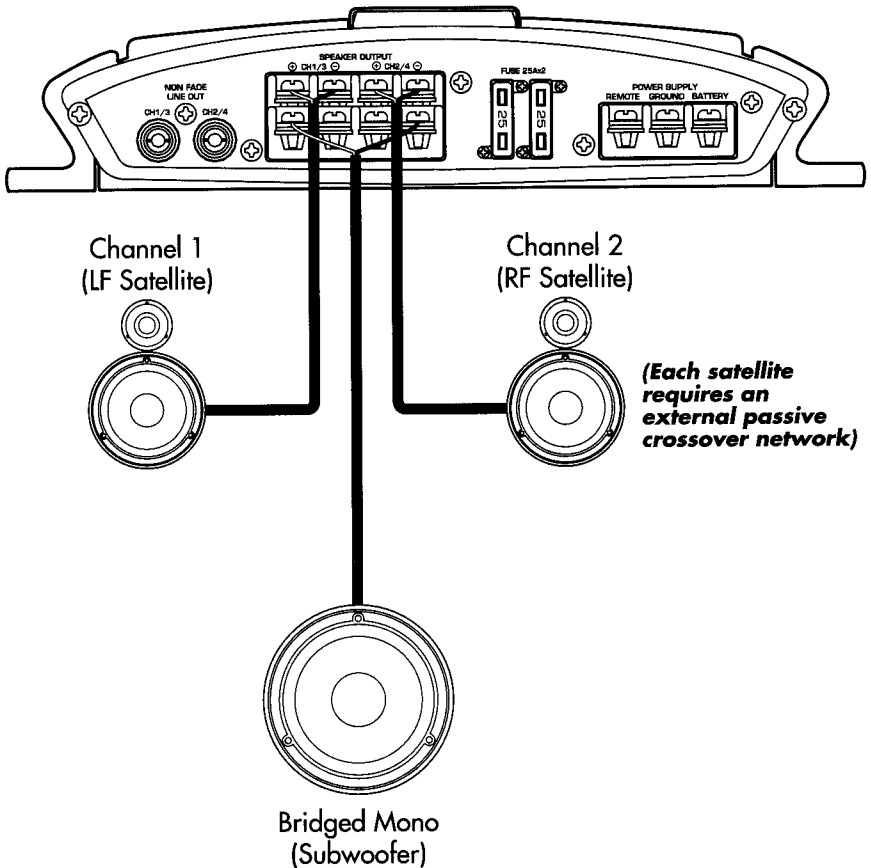
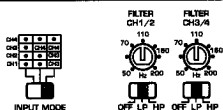

Figure 7. An APA4203 (or APA4162) can also be configured to drive a pair of stereo satellites for the front and a single mono subwoofer for the rear. Note the filter settings and connections.

# 2-Channel High Power Systems (Subwoofer or Satellites)

## FRONT PANEL SETTINGS



**Set Filter Frequencies to speaker manufacturer's specifications.**

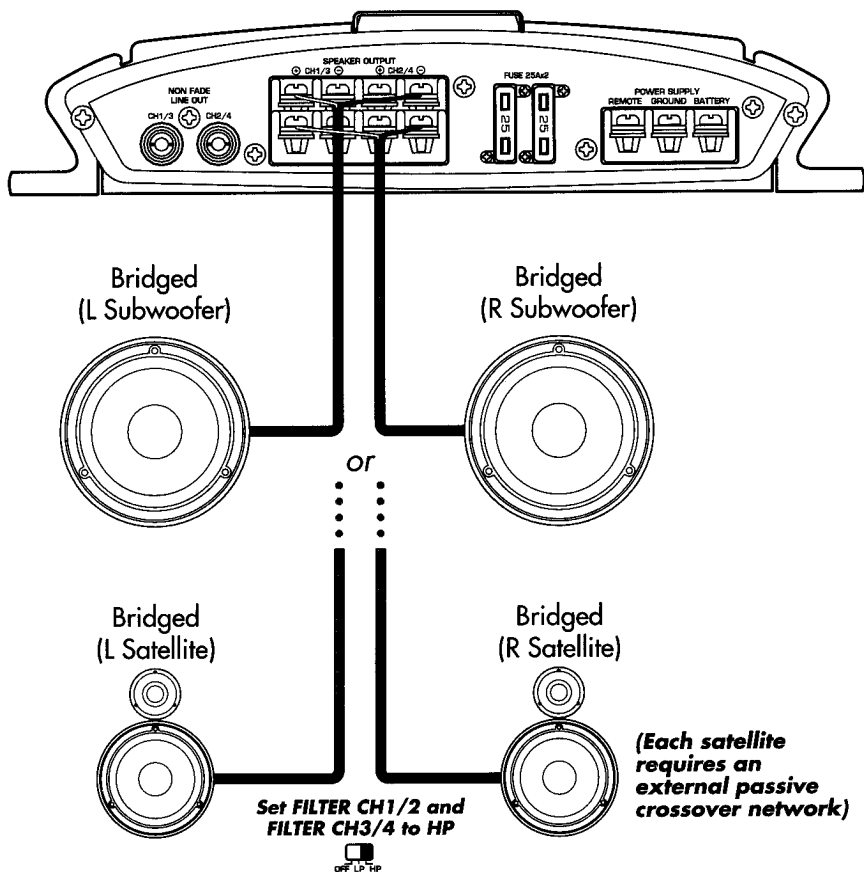

**(Each satellite requires an external passive crossover network)**

Figure 8. An APA4203 (or APA4162) can be set up as a 2-channel high-power amplifier to drive a pair of subwoofers (or satellites).

# Pre-Out Bi-Amped Stereo System

## FRONT PANEL SETTINGS

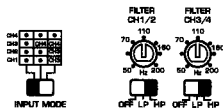

Set Filter Frequencies to speaker manufacturer's specifications.

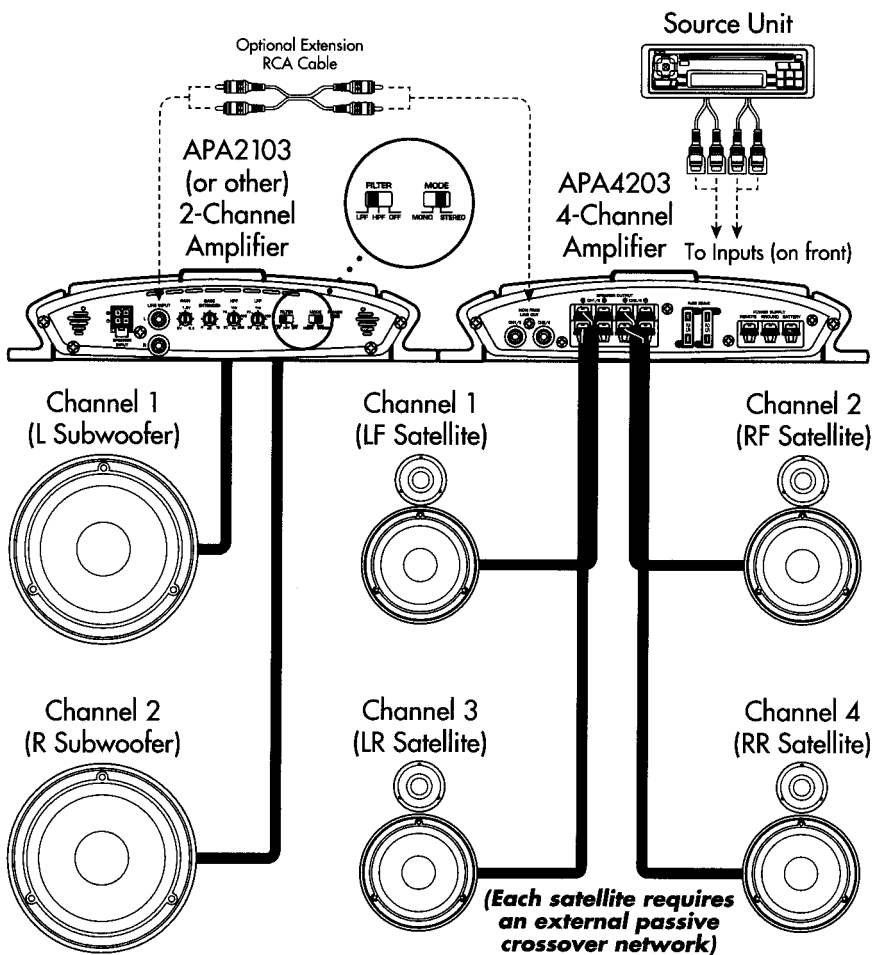
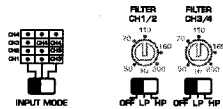

Figure 9. An APA4203 is shown here driving front and rear satellites, as well as feeding a 2-channel amplifier (e.g., Clarion APA2103) to drive a stereo pair of subwoofers. CH 1 and CH 3 sum internally to feed LINE OUT CH1/3, while CH 2 and CH 4 feed LINE OUT CH2/4.

# Mixed-Mode System On Rear Full-Range Speakers On Front

## FRONT PANEL SETTINGS



Set Filter Frequencies to speaker manufacturer's specifications.

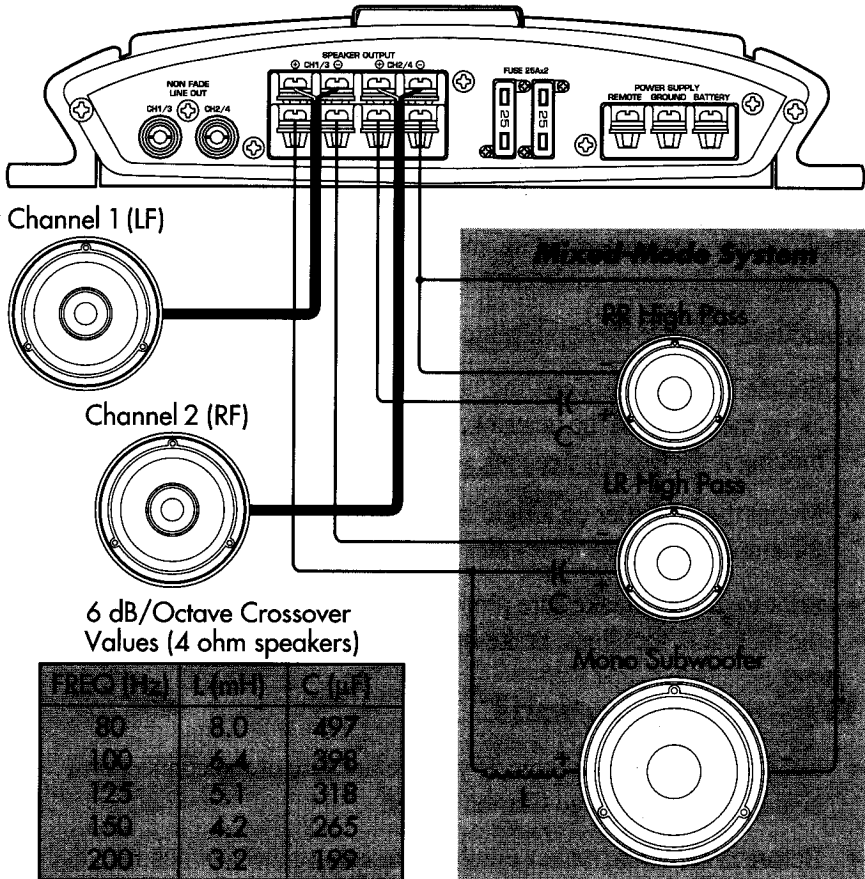

Figure 10. An APA4203 (or APA4162) can be configured for mixed-mode operation on either channel 1/2 or 3/4 amplifier sections. The component table provides optimum values to create a 6 dB/octave crossover at specified frequencies (i.e., do not overlap high and low frequencies). Use components that have a + 5% tolerance and capacitors rated at 100V.

## **INSTALLATION**

This section lists mounting and wiring precautions for installing a Clarion APA4203 (or APA4162) 4-channel car audio amplifier. Combined with the experience of a professional installer, these safeguards provide enough detail to successfully complete an installation. If you do not have the necessary skills, do not install the amplifier yourself. Instead, see your authorized Clarion dealer for installation recommendations.

### **Mounting Precautions**

Although the Clarion APA4203 (or APA4162) 4-channel car audio amplifier incorporates large heat sinks and protection circuits, mounting it in a tight space without any air movement can still damage internal circuits over time. Choose a site that provides adequate ventilation around the amplifier. For easy system set up, mount the amplifier so the controls on the front panel will be accessible after installation.

In addition, observe these precautions:

- ◆ For the most efficient cooling, mount the amplifier so cool air runs along the length of the heatsink, rather than across it. Remember, any moving air across the heatsink surface will dissipate heat.
- ◆ Mount the amplifier on a rigid surface inside the vehicle. Do not install the amplifier on plastic or other combustible materials.
- ◆ Prior to drilling, make sure proposed mounting holes will not cut into the fuel tank, fuel lines, brake lines (under chassis), or electrical wiring.

### **Wiring Precautions**

- ◆ Read all wiring precautions. If you are not sure of the connections, contact your authorized Clarion dealer.
- ◆ Before installation, make sure the source unit power switch is in the OFF position.
- ◆ Disconnect the negative (–) lead at the battery before making any power connections.

- ◆ When making connections, be sure that each connection is clean and secure. Insulate final connections with electrical tape or shrink tubing. Failure to do so may damage your equipment.
- ◆ A secure, clean ground connection is critical to the performance of your Clarion car audio amplifier. Use the shortest ground wire possible to minimize resistance and avoid noise problems.
- ◆ Refer to Figure 11 (below) when making electrical connections. Connect the amplifier's positive (+) power lead via a fuse directly to the positive (+) terminal on the battery. Do not connect this wire to the car's fuse panel. Use the power cable calculator chart (see Figure 12 on page 17) to determine the appropriate wire size for the amplifier's positive (+) power lead and the same-gauge black-insulated wire for the ground.

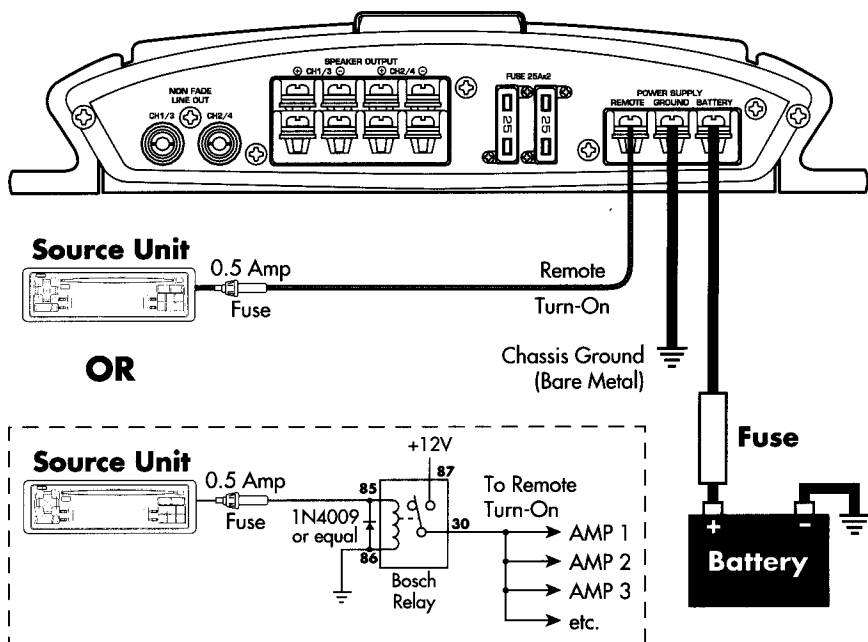

**Caution:** Clarion's Antenna/Amp output is restricted to 500 mA (MAXIMUM). Do not replace the 0.5 A fuse with a higher value or you will damage the unit. If more current is required when installing multiple amplifiers, use this relay circuit.

Figure 11. Electrical connections for an APA4203 amplifier. Connections for an APA4162 amplifier are similar.

# INSTALLATION

## Wiring Precautions (Continued)

- ◆ Add an external fuse on the positive (+) power lead and connect it as close as possible to the vehicle's (+) battery terminal. Use a rating that equals the total current consumption at full output of all amplifiers in the system. Adding an external fuse will protect the electrical system from short circuits that can cause a fire.
- ◆ When replacing the amplifier's fuse, always use one having the same current rating. Substituting a higher-rated fuse can reduce protection and may result in serious damage to the amplifier.
- ◆ Never ground the speakers to the vehicle chassis or body.
- ◆ Make sure that your vehicle's electrical system (i.e., alternator, battery, etc.) is capable of handling the additional load. If you are planning a multi-amplifier system, you may need to add a second battery and possibly upgrade the alternator with a higher-output-rated model. Consult your authorized Clarion dealer for recommendations.
- ◆ To avoid possible noise problems, run the amplifier's positive (+) power lead along one side of the vehicle to the battery. Run the remote turn-on wire and RCA audio cables down the center, and route the speaker wires along the remaining side. If wires must cross, run them perpendicular to each other.
- ◆ When creating passage holes for the power wire, use grommets to eliminate any sharp edges created during drilling. This will protect the wire from being nicked and causing a short circuit.
- ◆ Extra cable can cause signal loss and act as an "antenna" for noise. Use only high-quality RCA cables that are no longer than necessary to make a direct connection with the source unit or equalizer.
- ◆ Depending on the type of system being installed, refer to the examples in Figures 5 through 10 (starting on page 8) for information on wiring and setting the operation mode.



## Power Cable Calculator

Total System Amperage Draw	Cable 0' - 4'	Cable 4' - 7'	Cable 7' - 10'	Cable 10' - 13'	Cable 13' - 16'	Cable 16' - 19'	Cable 19' - 22'	Cable 22' - 28'
0 - 20 amperes	14	12	12	10	10	8	8	8
20 - 35 amperes	12	10	8	8	6	6	6	4
35 - 50 amperes	10	8	8	6	6	4	4	4
50 - 65 amperes	8	8	6	4	4	4	4	2
65 - 85 amperes	6	6	4	4	2	2	2	0
85 - 105 amperes	6	6	4	2	2	2	2	0
105 - 125 amperes	4	4	4	2	2	0	0	0
125 - 150 amperes	2	2	2	2	0	0	0	00

Figure 12. Use this chart to find a copper-wire gauge that will exhibit no more than a 0.5 volt drop for a desired cable length. If aluminum or tinned wire is used, select an even larger gauge size to compensate for material difference. NOTE: Cable-size calculations take into account terminal connection resistance.

## SETTING GAIN

1. Turn both CH 1/2 and CH 3/4 GAIN controls to their minimum (far left) positions. Also set BASS EXTENDER to 0 dB, and slide CH 1/2 FILTER and CH 3/4 FILTER to the proper positions for your application.
2. Turn the vehicle's ignition switch to the ON position. Then turn the ON/OFF switch on the source unit to the ON position. Set all tone or equalization controls to "flat" positions and turn loudness off.
3. Play a CD or tape and set the volume control at 75% of full level.
4. Verify that the POWER indicator on the amplifier comes on.

*NOTE: When using an equalizer, set its frequency controls to "flat."*

5. Set the fader control (on the source unit) to full front and slowly increase the CH 1/2 GAIN control for the front amplifiers (channels 1 and 2). Stop when you hear a slight distortion of audio. Set the fader to full rear and repeat this step for the rear amplifier using the CH 3/4 GAIN control.

## **USING THE HP/LP FILTERS**

*NOTE: Clarion recommends turning the amplifier off before changing any switch position to eliminate any possible damage from transient spikes to the amplifier or speaker system.*

1. Depending on your application, slide the FILTER CH 1/2 and FILTER CH 3/4 switches to HP (high-pass), LP (low-pass), or OFF positions.

*NOTE: If your application does not require a high-pass or low-pass filters, slide the CH 1/2 FILTER and CH 3/4 FILTER to OFF.*

2. Set the FILTER CH 1/2 and FILTER CH 3/4 controls to the recommended crossover points from the speaker manufacturer.
3. Listen to a variety of music styles (Rock, Rap, etc.) and slightly increase or decrease each filter control until the best performance is realized.

## **USING THE BASS EXTENDER**

1. Initially set the BASS EXTENDER control to its full left position (i.e., 0 dB).
2. Listen to a variety of music styles (e.g., Rock, Rap, etc.) and slowly increase the BASS EXTENDER control until a noticeable increase in low bass response is perceived.
3. Slowly adjust the BASS EXTENDER gain control (up or down) to realize the best bass response.

*CAUTION: If you hear a “pop” (due to speaker over-exursion), lower the BASS EXTENDER to prevent speaker damage. If the system sounds muddy and distorted (due to amplifier clipping), lower BASS EXTENDER to avoid shutdown from overheating.*

## FINAL SYSTEM CHECKS

1. Start the engine and turn on the source unit. After a two-second delay, slowly increase the volume control and listen to the audio. If you hear any noise, static, distortion, or no sound at all, check the connections, and also refer to *Troubleshooting* below. Depending on your system, the levels may be quite loud even at low volume settings. Until you get an “audio feel” of the system’s power, use care when adjusting controls.
2. Vary the balance control from left to right and listen to the results. Bass levels should not vary if the amplifier is configured using both L and R audio inputs.
3. Increase the volume and verify that the amplifier reproduces audio without distortion. If you hear distortion, check the connections and verify that the amplifier gain and BASS EXTENDER controls are set correctly. Another possibility is damaged (or under-powered) speakers. Once again, refer to *Troubleshooting* for additional help.

## TROUBLESHOOTING

<b>Symptom</b>	<b>Cause</b>	<b>Solution</b>
No audio	Low or no remote turn-on voltage	Check REMOTE wiring or add relay circuit if source unit fuse continues to blow
	Blown amplifier fuse	Replace with new fast-blow fuse (same rating)
	Power wires not connected	Check BATTERY and GROUND wiring at amplifier; check battery connections
	Speaker leads shorted	Check speaker continuity to ground; should not show a common ground

## TROUBLESHOOTING (CONT'D)

<b>Symptom</b>	<b>Cause</b>	<b>Solution</b>
No audio	Low or no remote Speakers not connected or are blown	Check REMOTE wiring Check speaker connections at amplifier; measure coil impedance
Audio cycles on and off	Thermal protection circuits are shutting amplifier off	Check location for adequate ventilation; consult an authorized Clarion dealer
Distorted audio	Gain is not set properly, or damaged speaker cones	Review <i>Setting Gain</i> on page 17; inspect each speaker cone for signs of damage (e.g., frozen cone, burning smell, etc.)
Audio lacks punch	Speakers wired incorrectly, which causes cancellation of bass frequencies	Check polarity of wires from amplifier to each speaker as defined by the system design
Amplifier fuse keeps blowing	Incorrect wiring or short circuit	Review <i>Installation</i> on page 14 and check all wiring connections
Whining or ticking noise in the audio with engine on	Amplifier is picking up alternator noise or radiated noise	Check power and ground connections on amplifier; check or move audio cables; install an in-line noise filter on source unit's power wire; check alternator and/or voltage regulator; test for weak battery or add water to battery

## **EVERYONE WANTS “MORE BASS”**

In the car audio environment, subsonic bass information (often called “thump”) requires three sizable components:

1. Speaker Piston Area (the size of the moving surface)
2. Cone Excursion (the amount of surface travel)
3. Power (the ability to move the surface)

In a home, bass is easily propagated (i.e., reproduce one complete cycle of an audio signal), whereas in a small vehicle, “air pressure” must be modulated to simulate propagation of the bass wave. Speaker piston area and cone excursion become the critical factors in producing low-frequency response.

As a general rule of thumb, remember that the smaller the speaker, the greater the mechanical cone travel required to produce low bass. The larger the speaker, the shorter the mechanical cone travel required to produce the same bass response.

A single subwoofer can only produce as much “pressure” as the piston area and the amount of mechanical cone excursion allow. Throwing more power on a single subwoofer may not be the best answer to more bass response. Adding multiple subwoofers to an audio system is often more economical than adding sheer brute amplifier power.

The best answer may be a combination of factors, including larger speakers, multiple drivers, and bigger amplifiers. This may require modification of the car’s electrical system, or special installation skills necessary to design and install multiple subwoofer speaker systems. Just how much bass is enough?

Everyone wants “more BASS” in the car audio environment. If this is your goal, we suggest visiting your local authorized Clarion dealer for professional system designs and installation options.

# SPECIFICATIONS

## APA4203 4-Channel Power Amplifier

Maximum Power Output:	500 watts (125 watts x 4)
Continuous Average Power Output:	50 watts x 4 into 4 ohms; 20 Hz to 20 kHz, 0.04% THD 75 watts x 4 into 2 ohms (typical); 20 Hz to 20 kHz, 0.4% THD 125 watts x 2 into 4 ohms; 20 Hz to 20 kHz, 0.4% THD
Frequency Response ( $\pm 1$ dB):	10 Hz to 50 kHz
Signal-to-Noise Ratio (A-wtd):	100 dB or better
Input Sensitivity (at rated output):	Low-Level (RCA): 200 mV to 5 V Speaker-Level: 400 mV to 10 V
Current Use (at rated output):	40 amps
Speaker Load Capacity:	4 ohms
Dimensions (W x H x L):	9 1/16" x 1 15/16" x 13" 230 mm x 48 mm x 330 mm

## APA4203 Speaker-Level Wire Codes

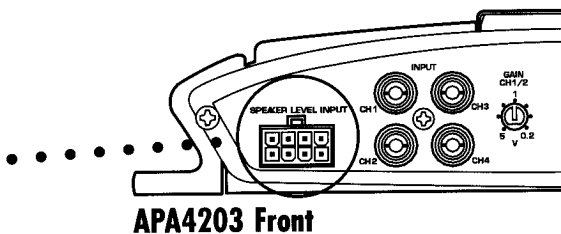
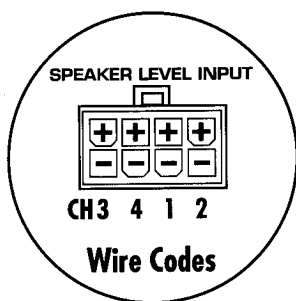

## **APA4162 4-Channel Power Amplifier**

Maximum Power Output:	440 watts (110 watts x 4)
Continuous Average Power Output:	40 watts x 4 into 4 ohms; 20 Hz to 20 kHz, 0.04% THD 65 watts x 4 into 2 ohms (typical); 20 Hz to 20 kHz, 0.4% THD 108 watts x 2 into 4 ohms; 20 Hz to 20 kHz, 0.4% THD
Frequency Response ( $\pm 1$ dB):	10 Hz to 50 kHz
Signal-to-Noise Ratio (A-wtd):	100 dB or better
Input Sensitivity (at rated output):	Low-Level (RCA): 200 mV to 5 V Speaker-Level: 400 mV to 10 V
Current Use (at rated output):	35 amps
Speaker Load Capacity:	4 ohms
Dimensions (W x H x L):	9 <sup>1</sup> / <sub>16</sub> " x 1 <sup>15</sup> / <sub>16</sub> " x 13" 230 mm x 48 mm x 330 mm

## **APA4162 Speaker-Level Wire Codes**

